

OCXO-20T5.0 5.0V Oven Controlled Crystal Oscillator

- 5 pin solder sealed in metal package (20.3 x 20.3 x 10.5) mm
- HCMOS Square Wave, AT-cut crystal or SC-cut crystal
- Voltage control (Electronic Frequency Tuning) is standard
- RoHS conform; Lead-free product
- Vibration: 10 to 2000 Hz / 10 G
- Shock: 2000 G, 0.3ms 1/2 sine
- Available in many standard and special frequencies

External Dimensions

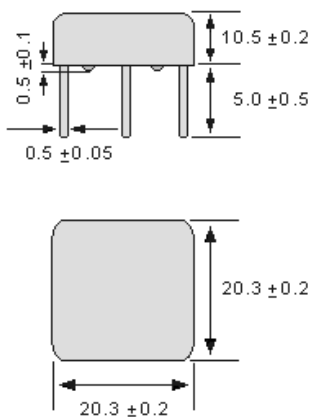

PIN CONNECTIONS

- 1 Supply Voltage
- 2 RF Output
- 3 Ground/ Case
- 4 Voltage Control EFC
- 5 Reference Voltage Output

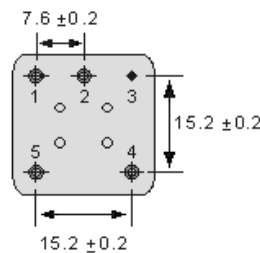

CMOS Output Square Wave Form

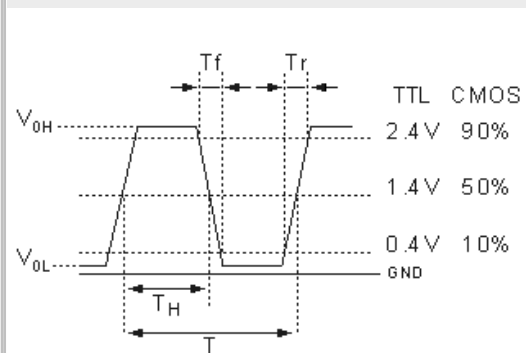

Specifications

Holder Type:	OCXO-20T5.0 5.0V (Voltage code is " 5.0 ")
Supply Voltage range:	+ 5.0V ± 0.2V
Frequency:	1.25 - 100.0 MHz
Initial Calibration Tolerance:	± 0.5ppm max., Vcon = + 2.5V
Frequency Stability:	(FS)
(FS) Operating Temperature Range:	AT-cut: 0~ 60°C ± 0.02 (ppm) / -20+ 70°C ± 0.05 (ppm) / -40+ 85°C ± 0.1 (ppm) SC-cut: 0~ 60°C ± 0.01 (ppm) / -20+ 70°C ± 0.01 (ppm) / -40+ 85°C ± 0.03 (ppm)
(FS) Warm up time (+ 25°C):	AT-cut: 3.0minutes (max.), within ± 0.5 ppm of its reference frequency SC-cut: 1.0minutes (max.), within ± 0.1 ppm of its reference frequency
(FS) Aging:	AT-cut: ± 5.0ppb max./day, 0.5 ppm max. first year, 3.0ppm over 10 years SC-cut: ± 2.0ppb max./day, 0.1 ppm max. first year, 0.5ppm over 10 years
(FS) Voltage Change:	± 0.20ppb, supply voltage ± 5% variation
(FS) Load Change:	± 0.20ppb, for ± 5% load condition change
Voltage Control on pin 4 (EFC):	Electronic Frequency Tuning
(EFC) Freq. Deviation Range:	AT-cut: ± 5.0ppm (min.), ± 20ppm (max.) fo at + 25°C + over operating temp.range SC-cut: ± 0.5ppm (min.), ± 2.0ppm (max.) fo at + 25°C + over operating temp.range
(EFC) Control Voltage Range:	2.5V ± 2.0V
(EFC) Transfer Function:	Positive: Increasing control voltage increases output frequency
(EFC) Input Impedance:	100 k (min.) // (EFC) Linearity ± 10 % (max.)
Power Dissipation (at 25°C):	steady-state : 250mA (max.) , turn-on: 500mW (max.)
Output:	Load (Fan out) : 15pF HCMOS (max.) Output Logic: High (Voh) + 4.5V (min), Low (Vol) + 0.5V (max.) Duty Cycle (at 50% Vcc) : 50% ± 10% Rise and Fall Time (20% to 80%) : 5ns (max.) (20% to 80% of waveform)
SSB Phase Noise AT-cut:	-75dBc/Hz @ 1Hz, -100dBc/Hz @ 10Hz, -130dBc/Hz @ 100Hz, -140dBc/Hz @ 1kHz, -150dBc/Hz @ 10kHz
SSB Phase Noise SC-cut:	-85dBc/Hz @ 1Hz, -120dBc/Hz @ 10Hz, -140dBc/Hz @ 100Hz, -145dBc/Hz @ 1kHz, -150dBc/Hz @ 10kHz
Storage Temperature:	-55- + 125°C

GERMANY:

COMTEC CRYSTALS GmbH · Sultenstrasse 12-14
8 5 5 8 6 P o i n g / G E R M A N Y
Phone + 49 8121 778160 · Fax + 49 8121 778177
e-Mail info@comtec-crystals.com
Internet: <http://www.comtec-crystals.com>
Subject to change without prior notice.



Technical Data and Graphics are all under
Copyright (c) of Comtec Crystals Group.

FRANCE:

COMTEC CRYSTALS SARL · 23, rue du Faucon
6 7 5 0 0 H a g u e n a u / F R A N C E
Phone + 33 388 732162 · Fax + 33 388 730118
e-Mail sales@comtec-crystals.com
Internet: <http://www.comtec-crystals.com>
Sous réserve de modifications.