

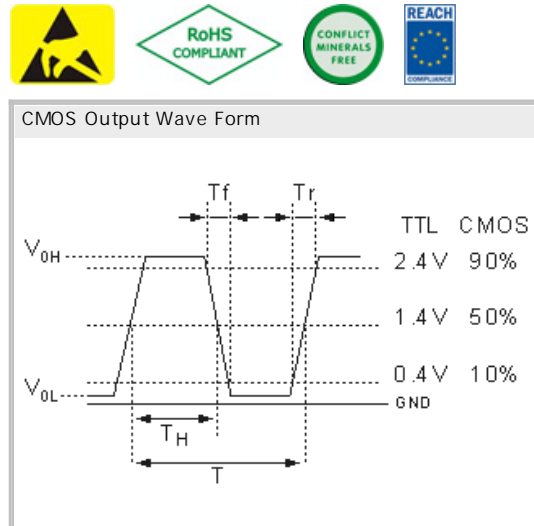

OCXO-14T5.0 5.0V
Oven Controlled Crystal Oscillator

- DIL in metal case (20.2 x 13.2 x 10.5) mm
- CMOS Square Wave, AT-cut crystal
- RoHS conform; Lead-free product
- Vibration: 10 to 2000 Hz / 10 G
- Shock: 2000 G, 0.3ms 1/2 sine
- Available in many standard and special frequencies

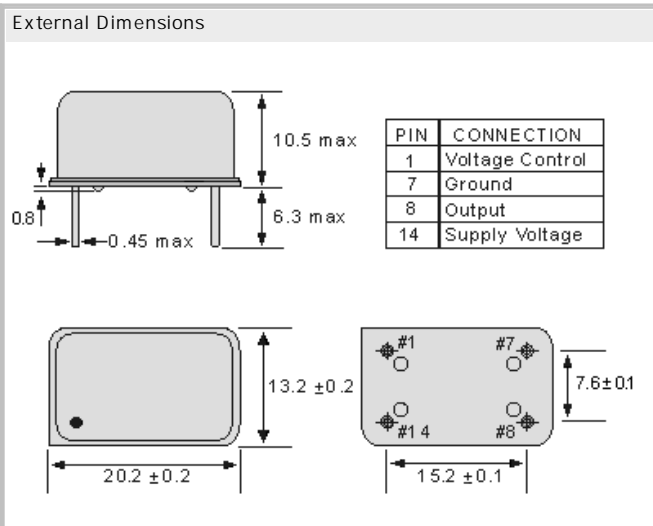

Specifications - Product No. G02500000DNWUPN43VA

Holder Type:	OCXO-14T5.0 5.0V (Voltage code is " 5.0 ")
Supply Voltage range:	+ 5.0V \pm 0.2V
Frequency:	25.000000 MHz
Initial Calibration Tolerance:	\pm 0.5ppm max., $V_{con} = +2.5V$
Frequency Stability (FS):	
(FS) Operating Temperature Range:	-40°C to +85°C, \pm 0.01ppm
(FS) Voltage Change:	(\pm 0.2V) < \pm 0.1ppm
(FS) Warm up time (+ 25°C):	3 minutes (max.)
(FS) Aging:	\pm 0.7 ppm first year, < 4.0ppm over 10 years
(FS) Load Change:	\pm 0.01ppm, for \pm 5% load condition change
Voltage Control on pin 1 (EFC):	Electronic Frequency Tuning
(EFC) Freq. Deviation Range:	\pm 4.0ppm (min.), Reference to fo at + 25°C
(EFC) Control Voltage Range:	(+ 5.0V) 0.0 to 5.0V
(EFC) Transfer Function:	Positive: Increasing control voltage increases output frequency
(EFC) Input Impedance:	47 k Ohm (min.)
(EFC) Linearity:	\pm 10 % (max.)
Power Dissipation (at 25°C):	steady-state : 1.5 W (max.) , turn-on: 2.5W (max.)
Output:	Load (Fan out) : 10LS Output Logic: High (Voh) + 4.5V (min), Low (Vol) + 0.4V (max.) Duty Cycle (at 50% Vcc) : 50% \pm 10% Rise and Fall Time (20% to 80%) : 7ns (max.) (20% to 80% of waveform)
Output Phase Noise (10.0 MHz):	-70dBc/Hz @ 1Hz, -100dBc/Hz @ 10Hz, -130dBc/Hz @ 100Hz, -140dBc/Hz @ 1kHz, -145dBc/Hz @ 10kHz

GERMANY:

COMTEC CRYSTALS GmbH · Sultenstrasse 12-14
8 5 5 8 6 P o i n g / G E R M A N Y
Phone +49 8121 778160 · Fax +49 8121 778177
e-Mail info@comtec-crystals.com
Internet: <http://www.comtec-crystals.com>
Subject to change without prior notice.



Technical Data and Graphics are all under
Copyright (c) of Comtec Crystals Group.

FRANCE:

COMTEC CRYSTALS SARL · 23, rue du Faucon
6 7 5 0 0 H a g u e n a u / F R A N C E
Phone +33 388 732162 · Fax +33 388 730118
e-Mail sales@comtec-crystals.com
Internet: <http://www.comtec-crystals.com>
Sous réserve de modifications.