

Programmable Crystal Clock Oscillator CXP7050TM1.8, 1.8V 1 -110MHz LVCMOS

- SMD in ceramic case (7.0 x 5.0 x 1.7) mm
- Tri-State Enable / Disable
- CMOS/TTL Square Wave
- on Tape & Reel (Tape 16mm) or on trays
- RoHS conform; Lead-free product
- Vibration: MIL-STD-202F method 204, 35G, 50 to 2000 Hz
- Shock: MIL-STD-202F method 213B, test cond. E, 1000G 1/2 sine wave
- Available in many standard and special frequencies

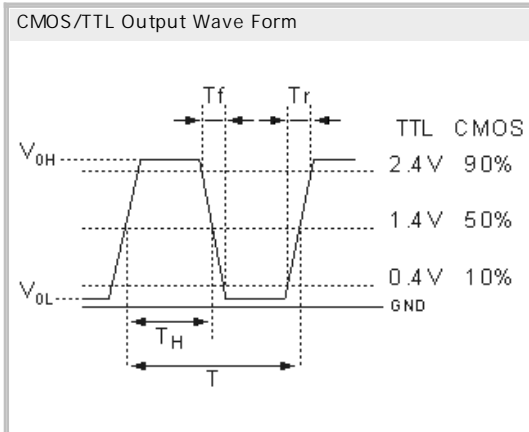
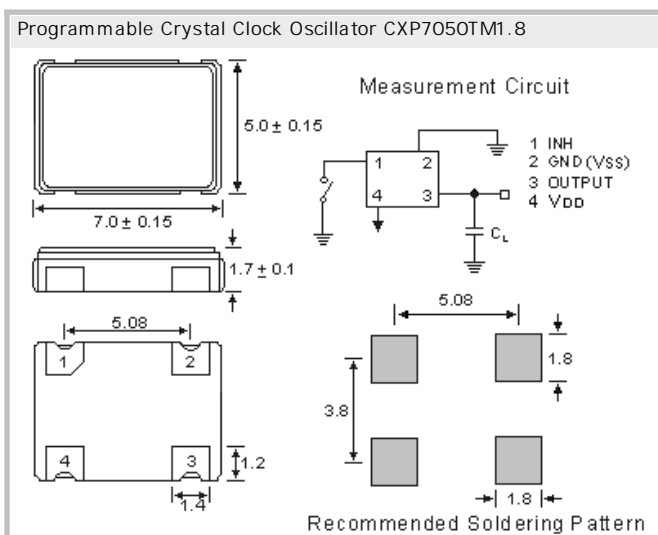

Specifications - Product No. G01200000KUSUPN43AB

Holder Type:	Programmable Crystal Clock Oscillator CXP7050TM1.8 LVCMOS
Frequency:	12.000000 MHz
Frequency Stability at 25°C:	± 25.0 ppm at 25°C
Operating Temperature Range:	± 25.0 ppm over -40°C to +85°C (inclusive of 25°C tolerance, ±10% input voltage variation, load change, aging, shock and vibration)
Storage Temperature:	-55°C to +150°C
Maximum Supply Current:	2.5 mA
Power Supply Voltage (V _{DD}):	+ 1.8V D.C. ± 10%
Rise/Fall Time:	4.0ns typ. (25MHz, PLL off) 1.5ns typ. (200MHz, PLL off)
Output Load:	15 pF CMOS
Start Up Time:	5ms max.
Output Symmetry (Duty Cycle):	50% ± 5% (measured at 50% V _{DD})
Period Jitter, peak to peak:	70ps typical
Low Phase Noise (typical):	-114dBc/Hz at 1KHz offset (133MHz)
Tri-state Function Pin 1 (option):	Pin 1 = H or open.... Output active at pin 3 Pin 1 = L.... high impedance at pin 3
Output Disable/Enable Time:	150 ns
Aging:	< ± 5ppm max. / year (max.)
Reflow Condition:	260°C max. for 10 sec.

GERMANY:

COMTEC CRYSTALS GmbH · Sultenstrasse 12-14
8 5 5 8 6 P o i n g / G E R M A N Y
Phone +49 8121 778160 · Fax +49 8121 778177
e-Mail info@comtec-crystals.com
Internet: <http://www.comtec-crystals.com>
Subject to change without prior notice.



Technical Data and Graphics are all under
Copyright (c) of Comtec Crystals Group.

FRANCE:

COMTEC CRYSTALS SARL · 23, rue du Faucon
6 7 5 0 0 H a g u e n a u / F R A N C E
Phone +33 388 732162 · Fax +33 388 730118
e-Mail sales@comtec-crystals.com
Internet: <http://www.comtec-crystals.com>
Sous réserve de modifications.