

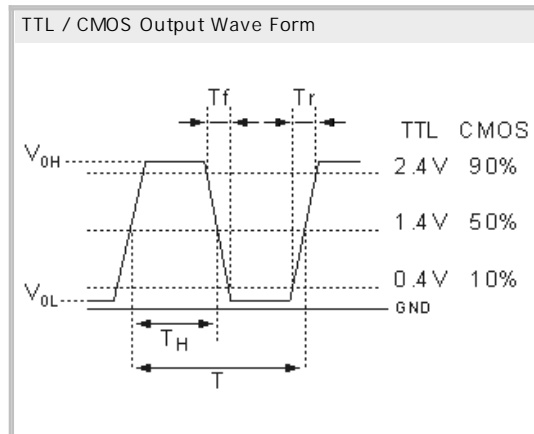

(VC)-TCXO-Oscillator SMD
(VC)-TCXO7050T5.0 5.0V

- Voltage Control
Temperature Compensated Crystal Oscillator
- SMD in ceramic case (7.0 x 5.0 x 2.3) mm
- TTL / CMOS Square Wave Output;
Wave form code is " T "
- RoHS conform; Lead-free product; Tape & Reel
- Vibration: MIL-STD-202F method 204,
35G, 50 to 2000 Hz
- Shock: MIL-STD-202F method 213B,
test cond. E, 1000GG 1/2 sine wave

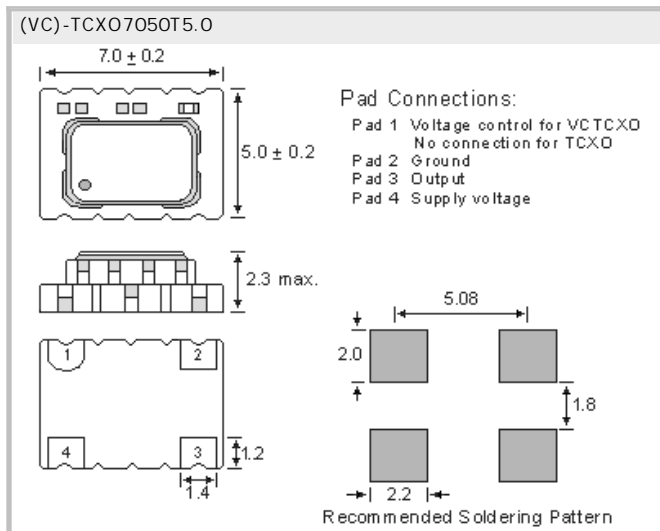

Specifications - Product No. G01200000CLQUPN00HA

Holder Type:	(VC)-TCXO7050T5.0 5.0V (Voltage code is " 5.0 ")
Frequency:	12.000000 MHz
Frequency Stability:	± 5.0 ppm at 25°C
Freq. Stability vs Temperature:	± 5.0 ppm from -20°C to +70°C
Freq. Stability vs Aging:	± 1.0 ppm, first year at 25 °C
Freq. Stability vs Voltage Change:	± 0.3 ppm, for a ± 5% input voltage change
Freq. Stability vs Load Change:	± 0.3 ppm, for a ± 10% load condition change
Operating Temperature Range:	-20°C to +70°C
Maximum Supply Current:	27.0 mA max.
Output Load:	15pF
Output Logic Levels:	Logic High "1" : 90% Vdd min.; Logic Low "0" : 10% Vdd max.
Output Symmetry (Duty Cycle):	40/60% ; Measured at 50% Vdd
Pin 1 Options VCTCXO only:	Control Voltage: Standard +1.5V ± 1.0V for all input voltages. Slope Polarity: Positive slope. Positive voltage for positive frequency shift. Input Impedance: 50kOhm min.; Linearity ±10% max. Modulation Bandwidth (at-3 dB) : 20kHz min.
Pin 1 Frequency Deviation Range:	± 5.0 ppm (min.) with Vcon = +1.5V ± 1.0V
Rise/Fall Time (10% to 90% Vdd):	10.0 nsec. max., 20% to 80% of the wave form
Phase Noise (typical) 10MHz:	-110dBc/Hz at 100Hz offset -125dBc/Hz at 1kHz offset -132dBc/Hz at 10kHz offset -125dBc/Hz at 100kHz offset
Start Up Time:	10 ms (max.), 5ms (typ.)
Storage Temperature:	-55 to +125°C
Reflow Condition:	260°C max. for 10 sec.

GERMANY:

COMTEC CRYSTALS GmbH · Sultenstrasse 12-14
8 5 5 8 6 P o i n g / G E R M A N Y
Phone +49 8121 778160 · Fax +49 8121 778177
e-Mail info@comtec-crystals.com
Internet: <http://www.comtec-crystals.com>
Subject to change without prior notice.



Technical Data and Graphics are all under
Copyright (c) of Comtec Crystals Group.

FRANCE:

COMTEC CRYSTALS SARL · 23, rue du Faucon
6 7 5 0 0 H a g u e n a u / F R A N C E
Phone +33 388 732162 · Fax +33 388 730118
e-Mail sales@comtec-crystals.com
Internet: <http://www.comtec-crystals.com>
Sous réserve de modifications.