

## HC49U



### Quartz Crystal Unit HC49U

- Standard Quartz Crystal
- Available with Radial Taping Package (from 1 k)
- Available in many standard and special frequencies
- RoHS conform; Lead-free product
- Link to Productgroup  
<http://www.comtec-crystals.com/produkte.php?id=C7>

### External Dimensions

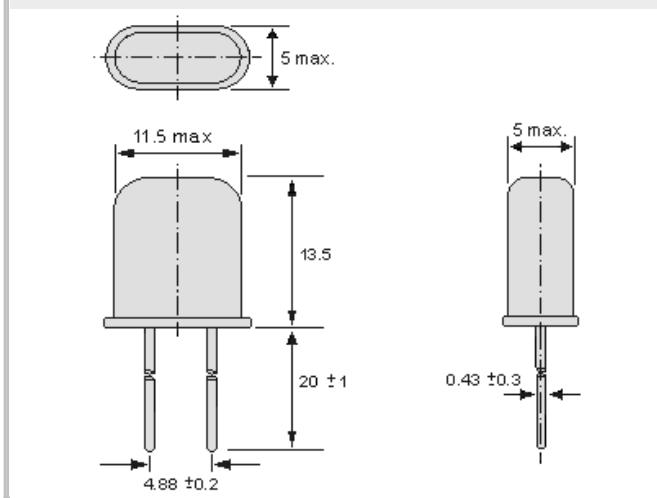

### Soldering Conditions

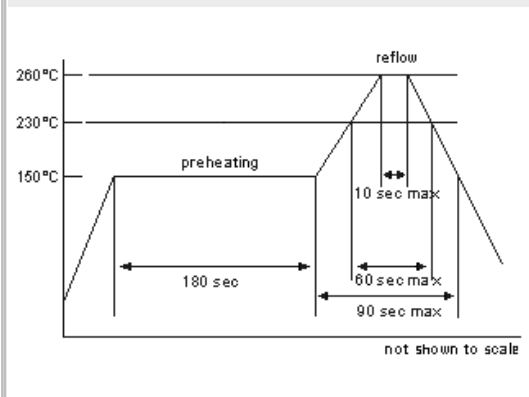

### Specifications - Product No. A049435000AA3EPS00DB

|                               |                             |
|-------------------------------|-----------------------------|
| Holder Type:                  | HC49U                       |
| Frequency:                    | 49.435000 MHz               |
| Frequency Stability at 25°C:  | ± 30 ppm                    |
| Temperature Stability:        | ± 50ppm @ -20°C to +70°C    |
| Storage Temperature:          | -50°C to +105°C             |
| Drive Level:                  | 100µW (500µW max.)          |
| Load Capacitance (CL):        | 30 pF                       |
| Shunt Capacitance (C0):       | < 7pF                       |
| Crystal Cut & Vibration Mode: | AT - cut, 3rd overtone      |
| Equivalent Series Resistance: |                             |
| Aging:                        | < ± 3ppm max. / year (max.) |

#### GERMANY:

COMTEC CRYSTALS GmbH · Sultenstrasse 12-14  
 8 5 5 8 6 P o i n g / G E R M A N Y  
 Phone +49 8121 778160 · Fax +49 8121 778177  
 e-Mail [info@comtec-crystals.com](mailto:info@comtec-crystals.com)  
 Internet: <http://www.comtec-crystals.com>  
 Subject to change without prior notice.



Technical Data and Graphics are all under  
 Copyright (c) of Comtec Crystals Group.

#### FRANCE:

COMTEC CRYSTALS SARL · 23, rue du Faucon  
 6 7 5 0 0 H a g u e n a u / F R A N C E  
 Phone +33 388 732162 · Fax +33 388 730118  
 e-Mail [sales@comtec-crystals.com](mailto:sales@comtec-crystals.com)  
 Internet: <http://www.comtec-crystals.com>  
 Sous réserve de modifications.