

HC49U



Quartz Crystal Unit HC49U

- Standard Quartz Crystal
- Available with Radial Taping Package (from 1 k)
- Available in many standard and special frequencies
- RoHS conform; Lead-free product
- Link to Productgroup
<http://www.comtec-crystals.com/produkte.php?id=C7>

External Dimensions

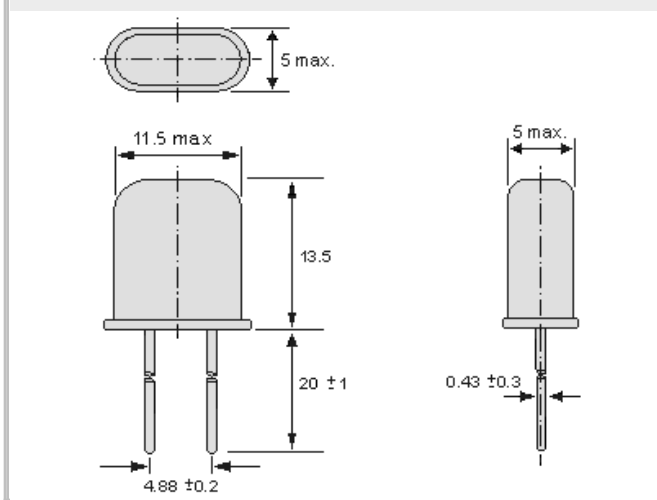

Soldering Conditions

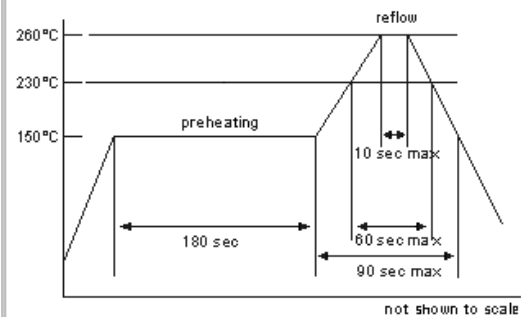

Specifications - Product No. A042575000AA3EPS00DB

Holder Type:	HC49U
Frequency:	42.575000 MHz
Frequency Stability at 25°C:	± 30 ppm
Temperature Stability:	± 50ppm @ -20°C to +70°C
Storage Temperature:	-50°C to +105°C
Drive Level:	100µW (500µW max.)
Load Capacitance (CL):	30 pF
Shunt Capacitance (C0):	< 7pF
Crystal Cut & Vibration Mode:	AT - cut, 3rd overtone
Equivalent Series Resistance:	
Aging:	< ± 3ppm max. / year (max.)

GERMANY:

COMTEC CRYSTALS GmbH · Sultenstrasse 12-14
 8 5 5 8 6 P o i n g / G E R M A N Y
 Phone +49 8121 778160 · Fax +49 8121 778177
 e-Mail info@comtec-crystals.com
 Internet: <http://www.comtec-crystals.com>
 Subject to change without prior notice.



Technical Data and Graphics are all under
 Copyright (c) of Comtec Crystals Group.

FRANCE:

COMTEC CRYSTALS SARL · 23, rue du Faucon
 6 7 5 0 0 H a g u e n a u / F R A N C E
 Phone +33 388 732162 · Fax +33 388 730118
 e-Mail sales@comtec-crystals.com
 Internet: <http://www.comtec-crystals.com>
 Sous réserve de modifications.