

HC49U



Quartz Crystal Unit HC49U

- Standard Quartz Crystal
- Available with Radial Taping Package (from 1 k)
- Available in many standard and special frequencies
- RoHS conform; Lead-free product
- Link to Productgroup
<http://www.comtec-crystals.com/produkte.php?id=C7>

External Dimensions

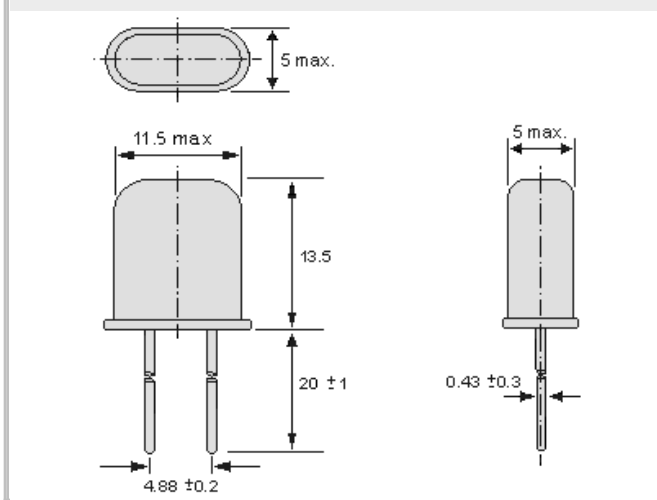

Soldering Conditions

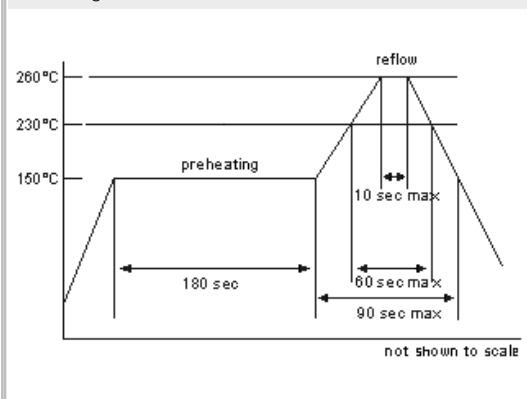

Specifications - Product No. A022579000AAFEPN00DB

| | |
|-------------------------------|-----------------------------|
| Holder Type: | HC49U |
| Frequency: | 22.579000 MHz |
| Frequency Stability at 25°C: | ± 30 ppm |
| Temperature Stability: | ± 50ppm @ -20°C to +70°C |
| Storage Temperature: | -50°C to +105°C |
| Drive Level: | 100µW (500µW max.) |
| Load Capacitance (CL): | 30 pF |
| Shunt Capacitance (C0): | < 7pF |
| Crystal Cut & Vibration Mode: | AT- cut, fundamental |
| Equivalent Series Resistance: | 25 Ohm max. |
| Aging: | < ± 3ppm max. / year (max.) |

GERMANY:

COMTEC CRYSTALS GmbH · Sultenstrasse 12-14
 8 5 5 8 6 P o i n g / G E R M A N Y
 Phone +49 8121 778160 · Fax +49 8121 778177
 e-Mail info@comtec-crystals.com
 Internet: <http://www.comtec-crystals.com>
 Subject to change without prior notice.



Technical Data and Graphics are all under
 Copyright (c) of Comtec Crystals Group.

FRANCE:

COMTEC CRYSTALS SARL · 23, rue du Faucon
 6 7 5 0 0 H a g u e n a u / F R A N C E
 Phone +33 388 732162 · Fax +33 388 730118
 e-Mail sales@comtec-crystals.com
 Internet: <http://www.comtec-crystals.com>
 Sous réserve de modifications.