

VCXO-Oscillator SMD VCXO7050T3-6pad, 3.3V Voltage Controlled Crystal Oscillator

- CMOS/TTL Output Wave Form
- SMD in ceramic case (7.0 x 5.0 x 1.8) mm, on Tape & Reel (Tape 16mm)
- with Tri-State Function, 3.3 V
- RoHS conform; Lead-free product
- Vibration: MIL-STD-202F method 204, 35G, 50 to 2000 Hz
- Shock: MIL-STD-202F method 213B, test cond. E, 1000GG 1/2 sine wave
- Available in many standard and special frequencies

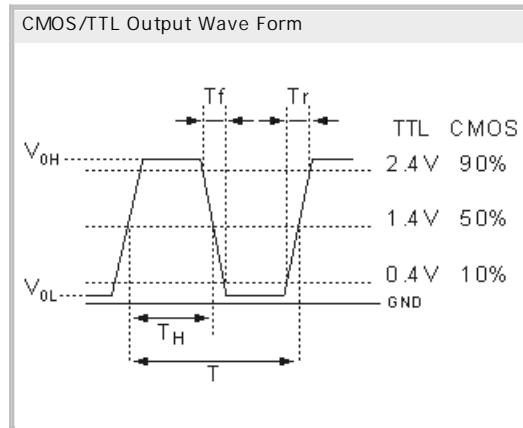
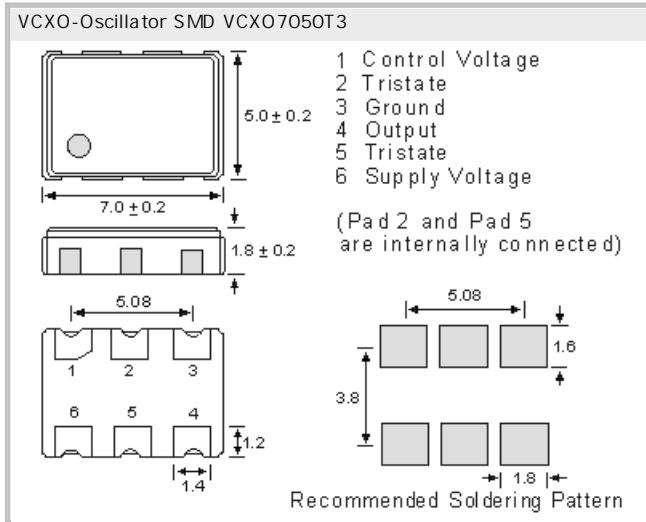

Specifications

Holder Type:	VCXO-Oscillator SMD VCXO7050T3.3-6pad 3.3V (Voltage code is "3.3")
Frequency:	32.768000 MHz
Initial Freq. Accuracy (at 25 °C):	To tune to the nominal frequency with $V_c = 1.65V \pm 0.2V$
Freq. Stability o.Operating Temp. Range:	± 50.0 ppm
Operating Temperature Range:	± 50.0 ppm over $-20^\circ C$ to $+70^\circ C$ (inclusive of $25^\circ C$ tolerance, $\pm 10\%$ input voltage variation, load change, aging, shock and vibration)
Deviation:	Frequency Range ± 100 ppm
Power Supply Voltage (Vdd):	+ 3.3V DC $\pm 10\%$
Maximum Supply Current:	20.0 mA
Output Load CL:	2 TTL gates max. / CMOS 15 pF
Output "1" Level (VOH):	2.4V (min.) TTL / 2.97V (min.) CMOS
Output "0" Level (VOL):	0.4V (max.) TTL / 0.33V (max.) CMOS
Output Symmetry (Duty Cycle):	45/55%
Tri-State Function:	Tri-State Enable High. No connection or $V_{dd} - 0.5V_{min}$. is applied to a Tri-state pin to enable output. Ground + 0.5Vmax. to disable output (high impedance).
Modulation Bandwidth (at -3 dB):	10KHz min, Vcontrol at 1.65V or at 2.5V
Voltage Control:	1.65V DC Center / 0.3V to 3.0V Range
Linearity:	6% typical; 10% max.
Rise/Fall Time TTL:	6ns (max.) 4ns (typ.) Measured between 0.4V and 2.4V
Rise/Fall Time CMOS:	6ns (max.) 4ns (typ.) Measured between 20% and 80% Vdd of the wave form (CL = 15pF)
Integrated Phase Jitter:	1 ps max. (12 kHz to 20 MHz)
Phase Noise (27MHz at 3.3V):	-40dBc/Hz at 10Hz offset -147dBc/Hz at 10kHz offset -104dBc/Hz at 100Hz offset -152dBc/Hz at 100kHz offset -132dBc/Hz at 1kHz offset -150dBc/Hz at 1MHz offset
Start Up Time:	10 ms (max.), 5ms (typ.)
Aging:	± 3 ppm per year (max.)
Input Impedance:	1 M Ohm typical
Reflow Condition:	10 sec. max. at $260^\circ C$

GERMANY:

COMTEC CRYSTALS GmbH · Sultenstrasse 12-14
8 5 5 8 6 P o i n g / G E R M A N Y
Phone +49 8121 778160 · Fax +49 8121 778177
e-Mail info@comtec-crystals.com
Internet: <http://www.comtec-crystals.com>
Subject to change without prior notice.



Technical Data and Graphics are all under
Copyright (c) of Comtec Crystals Group.

FRANCE:

COMTEC CRYSTALS SARL · 23, rue du Faucon
6 7 5 0 0 H a g u e n a u / F R A N C E
Phone +33 388 732162 · Fax +33 388 730118
e-Mail sales@comtec-crystals.com
Internet: <http://www.comtec-crystals.com>
Sous réserve de modifications.