

VCXO-Oscillator SMD VCXO7050T5.0-6pad, 5.0V Voltage Controlled Crystal Oscillator

- CMOS/TTL Output Wave Form
- SMD in ceramic case (7.0 x 5.0 x 1.8) mm, on Tape & Reel (Tape 16mm)
- with Tri-State Function, 3.3 V
- RoHS conform; Lead-free product
- Vibration: MIL-STD-202F method 204, 35G, 50 to 2000 Hz
- Shock: MIL-STD-202F method 213B, test cond. E, 1000GG 1/2 sine wave
- Available in many standard and special frequencies

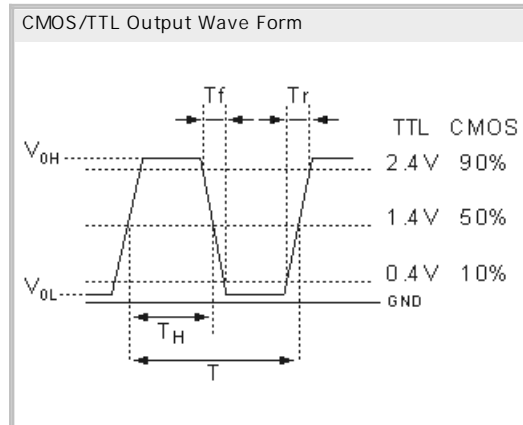
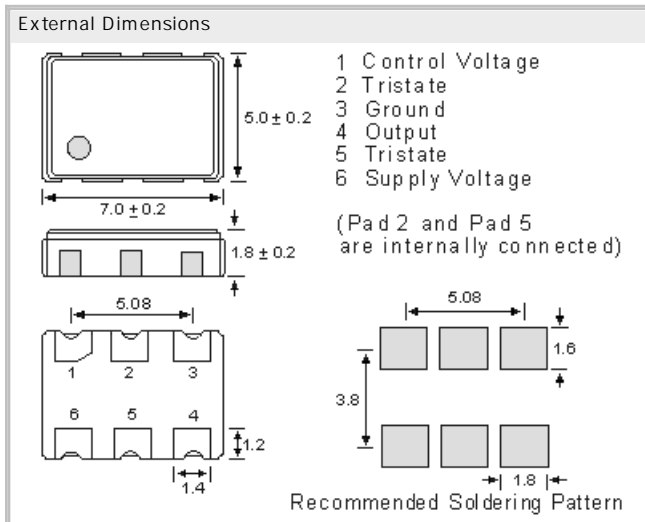

Specifications

| | |
|--|---|
| Holder Type: | VCXO7050T5.0-6pad 5.0V (Voltage code is " 5.0 ") Tri-State |
| Frequency: | 14.400000 MHz |
| Initial Freq. Accuracy (at 25 °C): | To tune to the nominal frequency with $V_c = 2.5V \pm 0.2V$ |
| Freq. Stability o.Operating Temp. Range: | ± 50.0 ppm |
| Operating Temperature Range: | ± 50.0 ppm over $-40^\circ C$ to $+85^\circ C$ (inclusive of $25^\circ C$ tolerance, $\pm 10\%$ input voltage variation, load change, aging, shock and vibration) |
| Frequency Deviation: | ± 100 ppm |
| Storage Temperature: | $-50^\circ C$ to $+105^\circ C$ |
| Power Supply Voltage (Vdd): | +5.0V DC $\pm 10\%$ |
| Maximum Supply Current: | 35.0 mA |
| Output Load CL: | 2 TTL gates max. / CMOS 15 pF |
| Output "1" Level (VOH): | 2.4V (min.) TTL / 4.5V (min.) CMOS |
| Output "0" Level (VOL): | 0.4V (max.) TTL / 0.5V (max.) CMOS |
| Output Symmetry (Duty Cycle): | 40/60% |
| Tri-State Function: | Tri-State Enable High. No connection or $V_{dd} - 0.5V_{min.}$ is applied to a Tri-state pin to enable output. $Ground + 0.5V_{max.}$ to disable output (high impedance). |
| Modulation Bandwidth (at -3 dB): | 10KHz min, $V_{control}$ at 1.65V or at 2.5V |
| Voltage Control: | 2.5V DC Center / 0.5V to 4.5V Range |
| Linearity: | 6% typical; 10% max. |
| Rise/Fall Time TTL: | 6ns (max.) 4ns (typ.) Measured between 0.4V and 2.4V |
| Rise/Fall Time CMOS: | 6ns (max.) 4ns (typ.) Measured between 20% and 80% V_{dd} of the wave form (CL = 15pF) |
| Integrated Phase Jitter: | 1 ps max. (12 kHz to 20 MHz) |
| Period Jitter: | RMS 2.0 ps (typ.) / Peak to Peak 14 ps max. |
| Phase Noise (27MHz at 3.3V): | -40dBc/Hz at 10Hz; -104dBc/Hz at 100Hz; -132dBc/Hz at 1kHz; -147dBc/Hz at 10kHz; -152dBc/Hz at 100kHz; -150dBc/Hz at 1MHz |
| Start Up Time: | 10 ms (max.), 5ms (typ.) |
| Aging: | ± 3 ppm per year (max.) |
| Input Impedance: | 1 MOhm typical |
| Reflow Condition: | 10 sec. max. at $260^\circ C$ |

GERMANY:

COMTEC CRYSTALS GmbH · Sultenstrasse 12-14
8 5 5 8 6 P o i n g / G E R M A N Y
Phone +49 8121 778160 · Fax +49 8121 778177
e-Mail info@comtec-crystals.com
Internet: <http://www.comtec-crystals.com>
Subject to change without prior notice.



Technical Data and Graphics are all under
Copyright (c) of Comtec Crystals Group.

FRANCE:

COMTEC CRYSTALS SARL · 23, rue du Faucon
6 7 5 0 0 H a g u e n a u / F R A N C E
Phone +33 388 732162 · Fax +33 388 730118
e-Mail sales@comtec-crystals.com
Internet: <http://www.comtec-crystals.com>
Sous réserve de modifications.

