

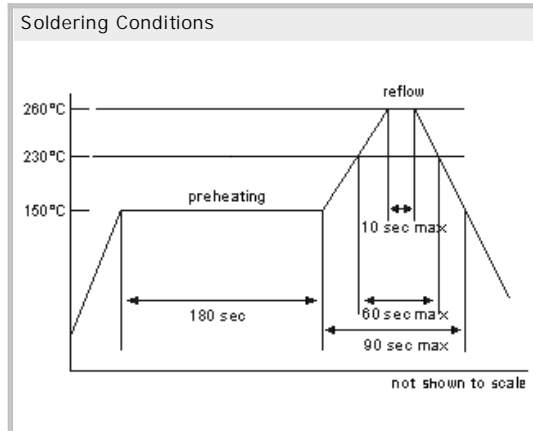

Quartz Crystal Unit HC49SM, h = 4.5mm max.

- Standard Quartz Crystal SMD with 2 pads
- Metal Case
- on Tape & Reel
- Available in many standard and special frequencies
- RoHS conform; Lead-free product

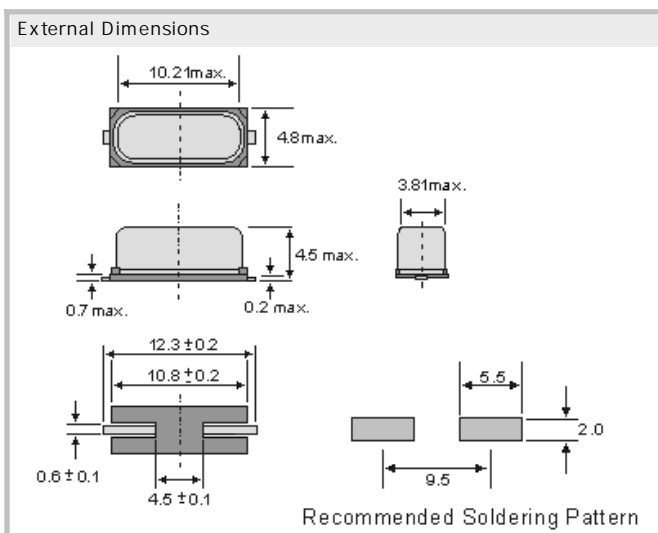

## Specifications - Product No. A008388608BAFBPN43DB

Holder Type:	HC-49SM with 2 pads
Frequency:	8.388608 MHz
Frequency Stability at 25°C:	± 30 ppm
Temperature Stability:	± 50ppm @ -40°C to +85°C
Storage Temperature:	-50°C to +105°C
Drive Level:	100µW (500µW max.)
Load Capacitance (CL):	16 pF
Shunt Capacitance (CO):	< 7pF
Crystal Cut & Vibration Mode:	AT- cut, fundamental
Equivalent Series Resistance:	50 Ohm max.
Aging:	< ± 3ppm max. / year (max.)

### GERMANY:

COMTEC CRYSTALS GmbH · Sultenstrasse 12-14  
 8 5 5 8 6 P o i n g / G E R M A N Y  
 Phone +49 8121 778160 · Fax +49 8121 778177  
 e-Mail [info@comtec-crystals.com](mailto:info@comtec-crystals.com)  
 Internet: <http://www.comtec-crystals.com>  
 Subject to change without prior notice.



Technical Data and Graphics are all under  
 Copyright (c) of Comtec Crystals Group.

### FRANCE:

COMTEC CRYSTALS SARL · 23, rue du Faucon  
 6 7 5 0 0 H a g u e n a u / F R A N C E  
 Phone +33 388 732162 · Fax +33 388 730118  
 e-Mail [sales@comtec-crystals.com](mailto:sales@comtec-crystals.com)  
 Internet: <http://www.comtec-crystals.com>  
 sous réserve de modifications.